

Designed by Leonid Ciunel	Checked by	Approved by	Date	Date 03-Jan-12	
TELEMED			SmartUs		
			SU 192	Edition	Sheet 1 / 3

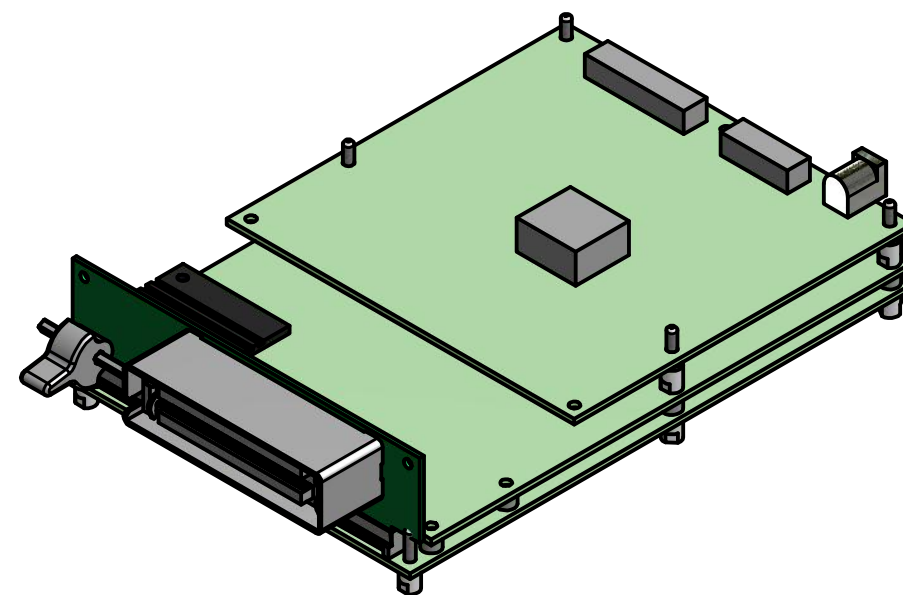

Designed by Leonid Ciunel	Checked by	Approved by	Date	Date 03-Jan-12	
TELEMED			SmartUs		
			SU 192	Edition	Sheet 2 / 3

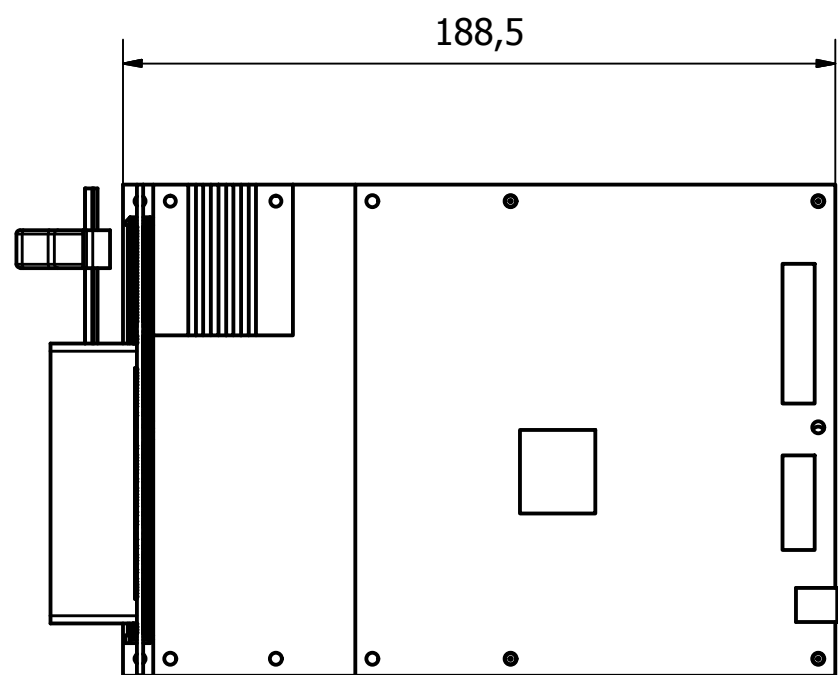
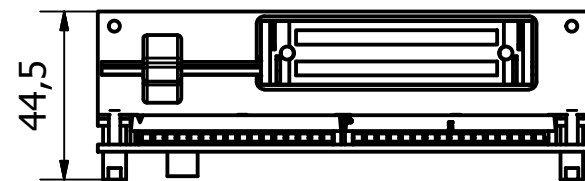
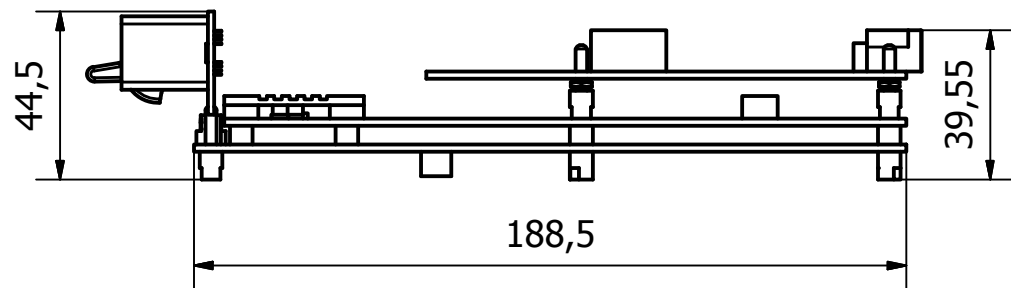
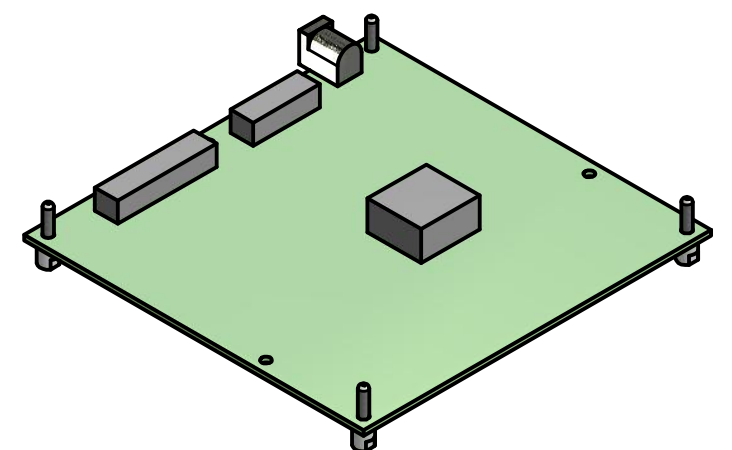
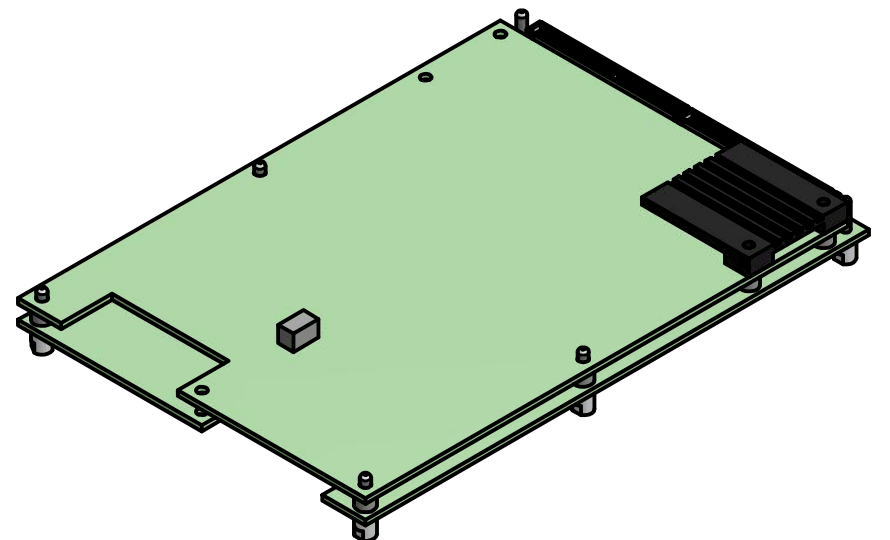
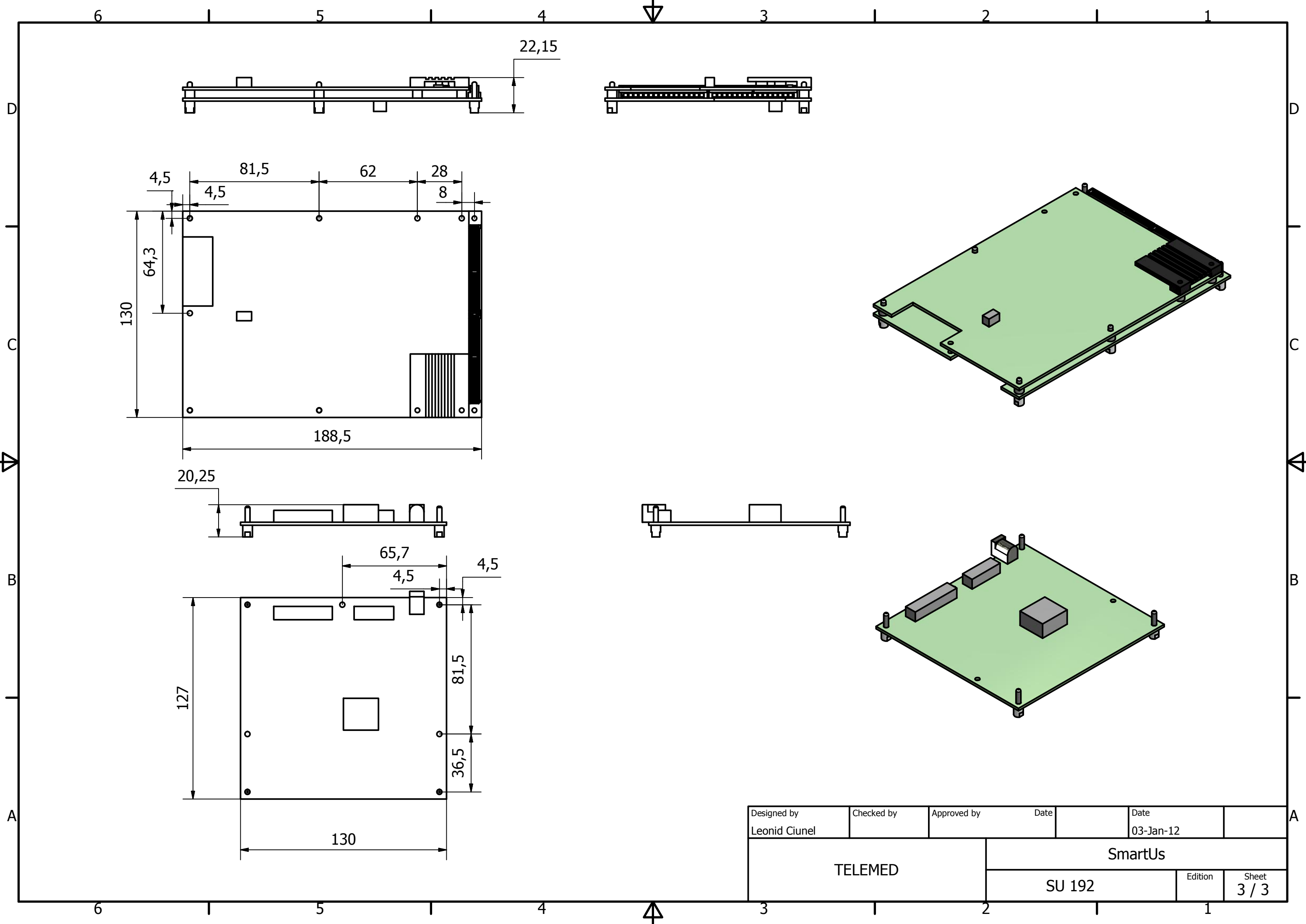

Designed by Leonid Ciunel	Checked by	Approved by	Date	Date 03-Jan-12	
TELEMED			SmartUs		
			SU 192	Edition	Sheet 3 / 3